

P-15776

E0474

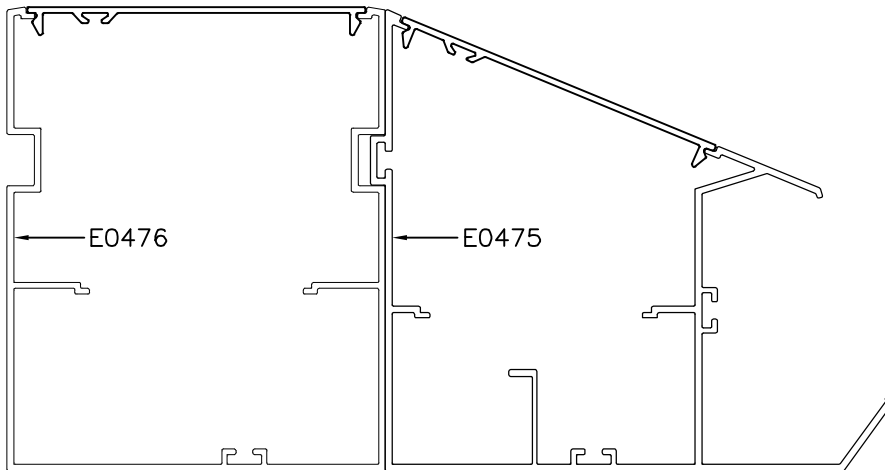
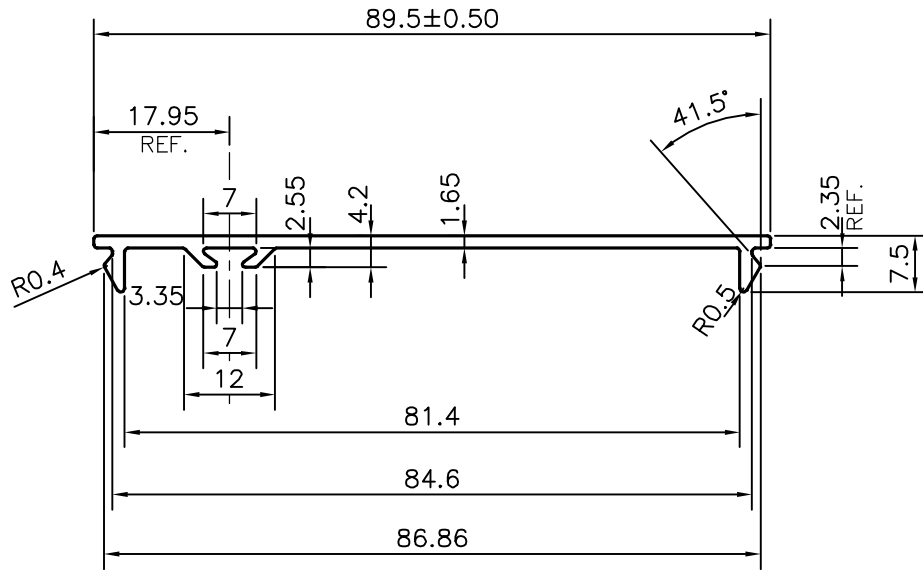

SYMBOL OF QUALITY
AN ISO 9001 COMPANY

JINDAL ALUMINIUM LTD.
BANGALORE-560073 (INDIA)

	NAME	DATE
DRAWN	J.P.KAUSHIK	26-04-2016
CHECKED		
APPROVED	B. NATARAJ	09-05-2016
SCALE		1:1
AREA mm ²		180.4
PERIMETER mm.		215.85
WEIGHT kg/m		0.487
DRAWING No.	SECTION No.	
P-15776	-	
E0474	E0474	

1. ALL DIMENSIONS ARE IN mm.
2. ROUND OFF ALL SHARP CORNERS WITH 0.40 mm.
3. TOLERANCES WILL BE AS PER,IS:3965-1981 UNLESS OTHERWISE SPECIFIED

PARTY'S NAME	DRAEGER MEDICAL INDIA PVT. LTD., MUMBAI
PARTY'S DRAWING No.	AS PER AutoCAD DRAWING
ALLOY & TEMPER	6060 T6
DESCRIPTION	CLIP SECTION