

P-JAL-B-649

G102591

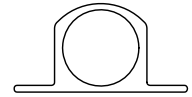

SCALE 1:1

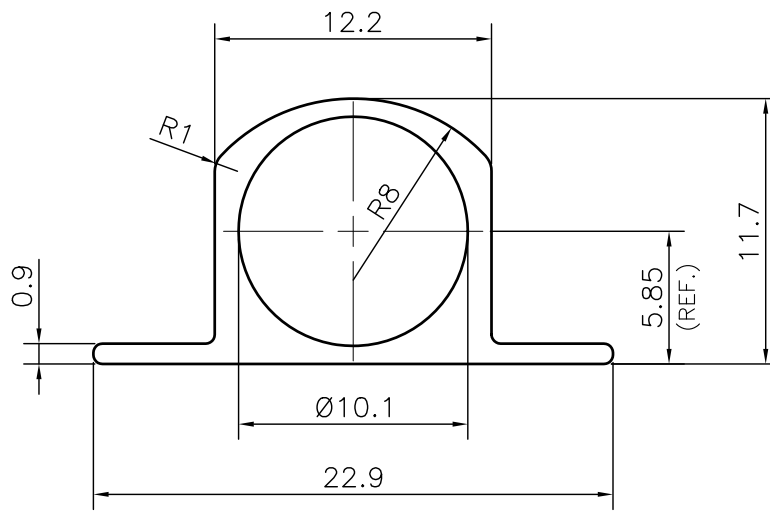

WEIGHT :- 0.607 KG/12 FEET

- 1. STRAIGHTNESS= 1.7mm/M
- 2. TWIST= 1.7mm/M
- 3. ANGULARITY= ±2°
- 4. FLATNESS= 0.007xWIDTH

Q02110

CONTROLLED COPY



SYMBOL OF QUALITY AN ISO 9001 COMPANY

JINDAL ALUMINIUM LTD. BHIWADI-301019 (INDIA)

	NAME	DATE
DRAWN	ASHUTOSH	12-07-2024
CHECKED	PARVESH	02-08-2024
APPROVED	J.N.RAI	02-08-2024
SCALE		3:1
AREA mm ²		61.619
PERIMETER mm.		64.128
WEIGHT kg/m		0.166
DRAWING No.	SECTION No.	
P-JAL-B-649	7000002741	
G102591	G102591	

- 1. ALL DIMENSIONS ARE IN mm.
- 2. ROUND OFF ALL SHARP CORNERS WITH 0.40 mm.
- 3. TOLERANCES WILL BE AS PER BS:EN-755-9 , UNLESS OTHERWISE SPECIFIED

PARTY'S NAME	IMPERIAL METAL MART	
PARTY'S DRAWING No.	AS PER DRAWING	
ALLOY & TEMPER	HE9WP A3D	PRODUCT CODE:-030
		HSN CODE:- 76042100
DESCRIPTION	TOWER BOLT SECTION	