

P-14593-3

S4491

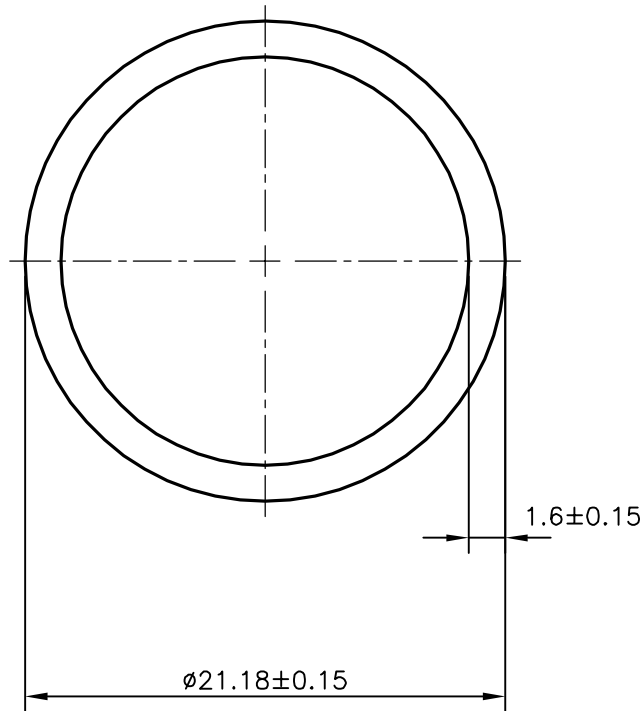
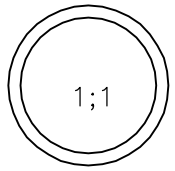

SYMBOL OF QUALITY
AN ISO 9001 COMPANY

JINDAL ALUMINIUM LTD.
BANGALORE-560073 (INDIA)

	NAME	DATE
DRAWN	J.P.KAUSHIK	02-06-2015
CHECKED		
APPROVED	S.S.GARG	16-06-2015
SCALE		3:1
AREA mm ²		98.42
PERIMETER mm.		66.539
WEIGHT kg/m		0.266
DRAWING No.	SECTION No.	
P-14593-3	-	
S4491	S4491	

1. ALL DIMENSIONS ARE IN mm.
2. ROUND OFF ALL SHARP CORNERS WITH 0.40 mm.
3. TOLERANCES WILL BE AS PER IS:2673-2002 UNLESS OTHERWISE SPECIFIED

PARTY'S NAME	MEDIPEDIC SURGICALS, VALSAD
PARTY'S DRAWING No.	AS PER SPECIFICATION & REQUIREMENT
ALLOY & TEMPER	6063 T6
DESCRIPTION	ROUND TUBE