

P-15756

X2005

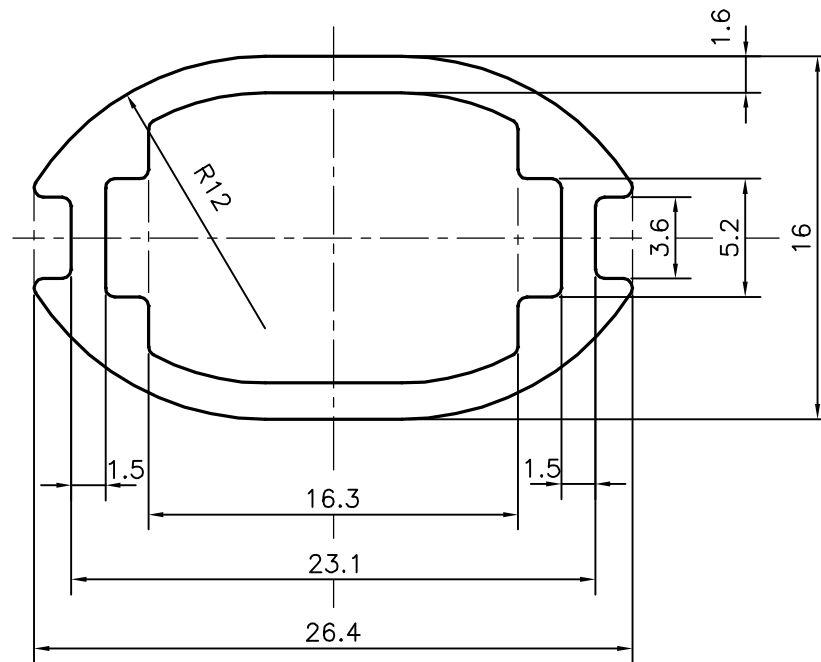
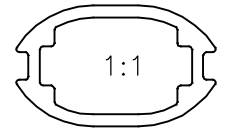

SYMBOL OF QUALITY
AN ISO 9001 COMPANY

JINDAL ALUMINIUM LTD.
BANGALORE-560073 (INDIA)

	NAME	DATE
DRAWN	J.P.KAUSHIK	07-04-2016
CHECKED		
APPROVED	S.S. GARG	14-04-2016
SCALE		3:1
AREA mm ²		123.152
PERIMETER mm.		75.244
WEIGHT kg/m		0.333
DRAWING No.	SECTION No.	
P-15756	-	
X2005	X2005	

1. ALL DIMENSIONS ARE IN mm.
2. ROUND OFF ALL SHARP CORNERS WITH 0.40 mm.
3. TOLERANCES WILL BE AS PER, IS:6477-1983 UNLESS OTHERWISE SPECIFIED

PARTY'S NAME	FALCON GARDEN TOOLS PVT. LTD., LUDHIANA
PARTY'S DRAWING No.	AS PER DRAWING
ALLOY & TEMPER	HE9 WP
DESCRIPTION	OVAL TUBE MISC.