

P-17143

X2200

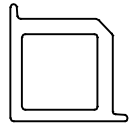

SCALE: - 1:1

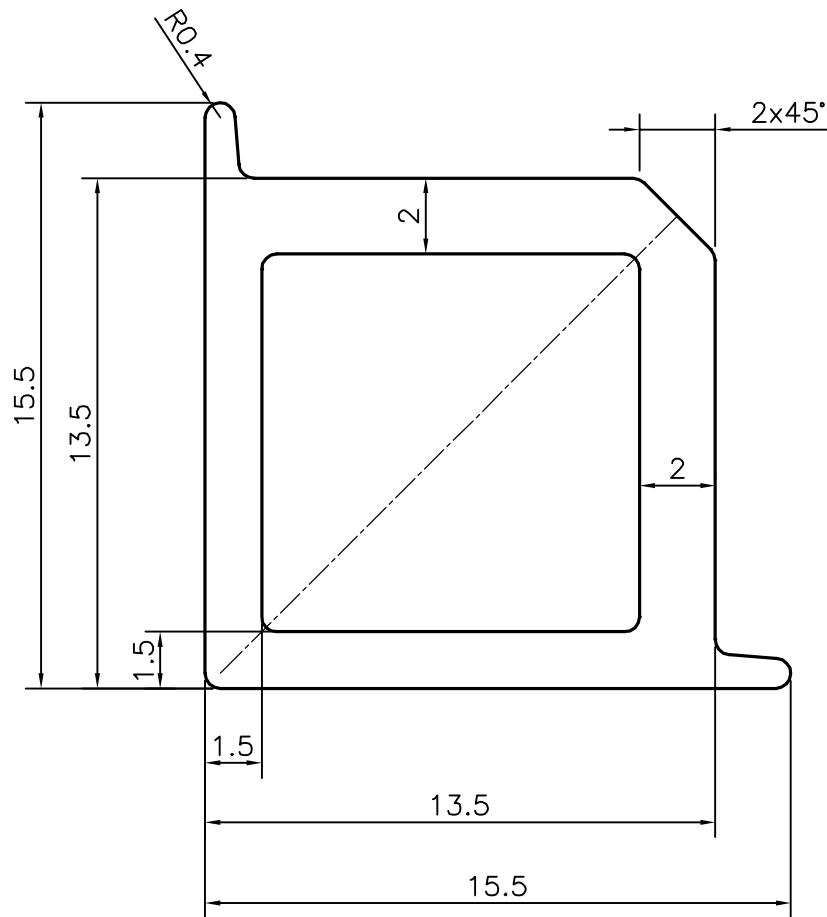

TOLERANCES ON OVERALL WIDTHS & WIDTHS ACROSS FLATS OF BARS, & REGULAR SECTIONS

UPTO 6.40mm - ±0.20	UPTO 32.0mm - ±0.38	UPTO 120.0mm - ±0.85	1. STRAIGHTNESS=1.7mm/M 2. TWIST=1.7mm/M 3. ANGULARITY= ±2° 4. FLATNESS =0.007xWIDTH
UPTO 10.0mm - ±0.23	UPTO 50.0mm - ±0.46	UPTO 160.0mm - ±1.02	
UPTO 12.0mm - ±0.25	UPTO 60.0mm - ±0.53	UPTO 200.0mm - ±1.14	
UPTO 16.0mm - ±0.28	UPTO 80.0mm - ±0.69	UPTO 250.0mm - ±1.40	
UPTO 25.0mm - ±0.30	UPTO 100.0mm - ±0.75	UPTO 300.0mm - ±1.65	



SYMBOL OF QUALITY
AN ISO 9001 COMPANY

JINDAL ALUMINIUM LTD.
BANGALORE-560073 (INDIA)

	NAME	DATE
DRAWN	PARVESH	17-05-2017
CHECKED		
APPROVED	B.NATARAJA	16-06-2017

1. ALL DIMENSIONS ARE IN mm.
2. ROUND OFF ALL SHARP CORNERS WITH 0.40 mm.
3. TOLERANCES WILL BE AS PER IS:6477-1983 , UNLESS OTHERWISE SPECIFIED

SCALE	5:1
AREA mm ²	83.671
PERIMETER mm.	59.406
WEIGHT kg/m	0.226

PARTY'S NAME	TEAM WORK GLASS SOLUTIONS PVT LTD., HYDERABAD
PARTY'S DRAWING No.	CN-04
ALLOY & TEMPER	6063 T6
DESCRIPTION	ARCHITECTURAL SECTION

DRAWING No.	SECTION No.
P-17143	-
X2200	X2200