

P-18846-1

X2459

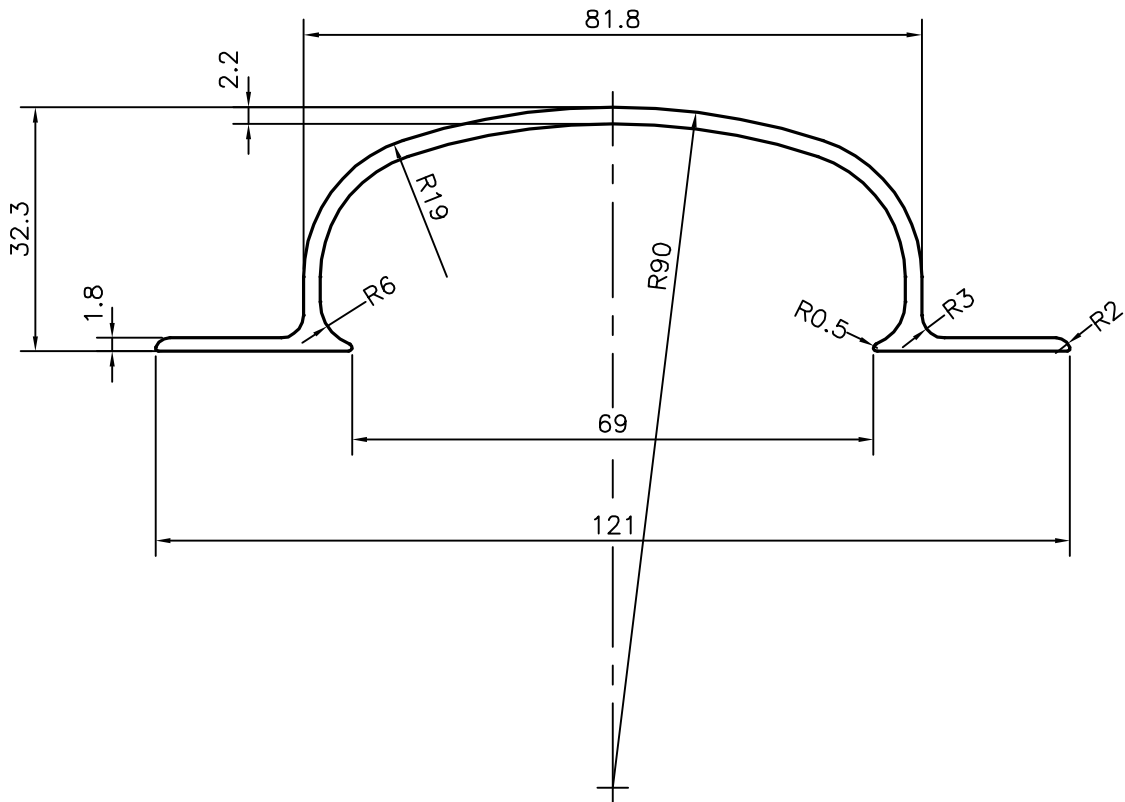

SYMBOL OF QUALITY
AN ISO 9001 COMPANY

JINDAL ALUMINIUM LTD.
BANGALORE-560073 (INDIA)

	NAME	DATE
DRAWN	DARPAN	22-11-2018
CHECKED		
APPROVED	B.NATARAJA	14-12-2018
SCALE		1:1
AREA mm ²		357.797
PERIMETER mm.		330.772
WEIGHT kg/m		0.966
DRAWING No.	SECTION No.	
P-18846-1	-	
X2459	X2459	

1. ALL DIMENSIONS ARE IN mm.
2. ROUND OFF ALL SHARP CORNERS WITH 0.40 mm.
3. TOLERANCES WILL BE AS PER IS:3965-1981 , UNLESS OTHERWISE SPECIFIED

PARTY'S NAME	IMPERIAL METAL MART, NEW DELHI
PARTY'S DRAWING No.	AS PER SAMPLE & REQUIRMENT
ALLOY & TEMPER	HE9 WP A3D
DESCRIPTION	"C" TYPE HANDLE SECTION